



NOTES:

1. MATERIAL:
 - 1.1 HOUSING: THERMOPLASTIC, HIGH TEMP., UL94V-0; COLOR:BLACK.
 - 1.2 CONTACT: COPPER ALLOY
 - 1.3 FITTING NAIL: COPPER ALLOY
2. FINISH:
 - 2.1 CONTACT: 50u" MIN. NICKEL UNDERPLATING OVERALL
L:60u" MIN PURE TIN OVERALL
3. REFER TO PS-57957-XXXX-XXX
4. PACKAGE PLS. REFER TO 57923-XXXX-XX-TRP
5. PART NUMBER

57923-XXX X X-XXX

NO OF CKT 001:NORMAL
 4:TAPE&REEL PLATING
 WITH MYLAR L:PURE TIN

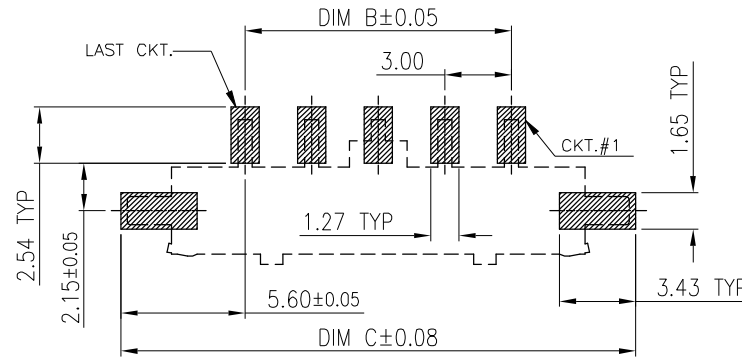

RECOMMENDED PCB LAYOUT
 GENERAL TOLERANCE ±0.05

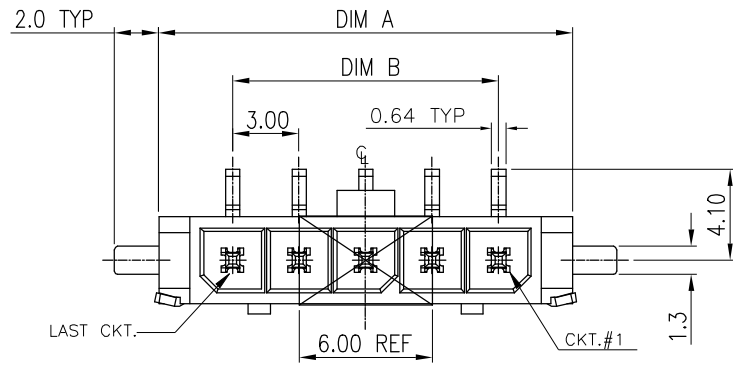

CKT	DIM A	DIM B	DIM C
2	9.65	3.00	14.20
3	12.65	6.00	17.20
4	15.65	9.00	20.20
5	18.65	12.00	23.20
6	21.65	15.00	26.20
7	24.65	18.00	29.20
8	27.65	21.00	32.20
9	30.65	24.00	35.20
10	33.65	27.00	38.20
11	36.65	30.00	41.20
12	39.65	33.00	44.20

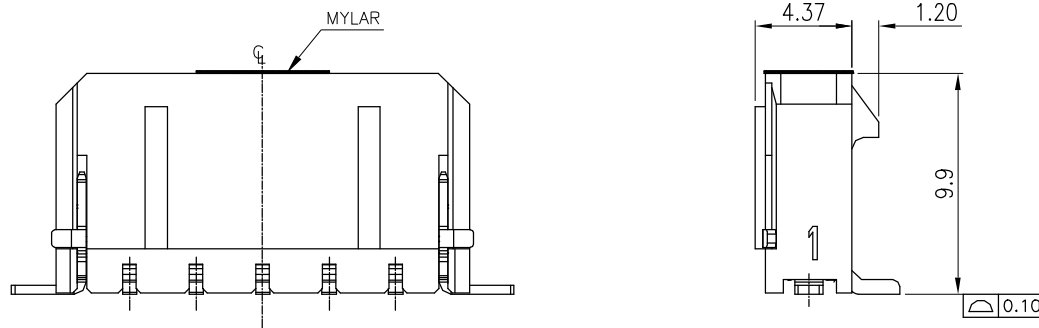

QUALITY SYMBOLS MAJOR Ⓢ CRITICAL Ⓢ GENERAL TOLERANCES (UNLESS SPECIFIED) X. ±0.5 .X ±0.38 .XX ±0.25 .XXX ±0.15 ANGLES ±2°	DRAWN BY Tang,En Hul 19/08/20	DATE 19/08/20	
	CHECKED BY Lu,ling Quan 19/08/20	DATE 19/08/20	
	APPROVED BY hsieh, fu yu 19/08/20	DATE 19/08/20	RFG NO. N/A
	UNITS mm		SIZE A4
	SCALE 3:1	SHEET NO. 1 OF 2	REV A
			DWG NO. 57923-XXXX-XXX

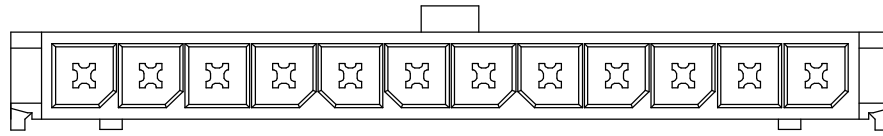

12-CKT

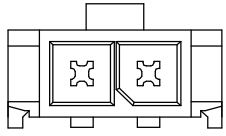

2-CKT

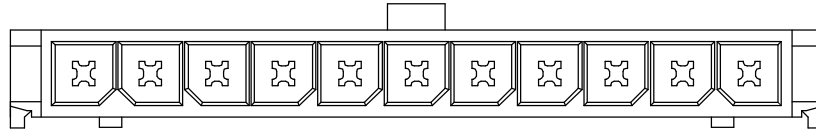

11-CKT

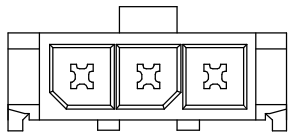

3-CKT

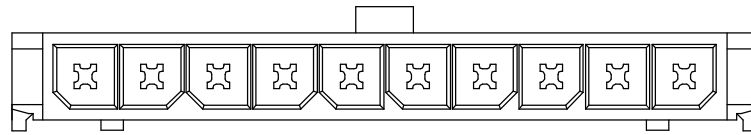

10-CKT

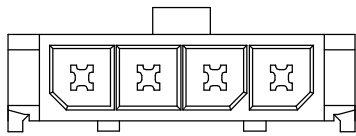

4-CKT

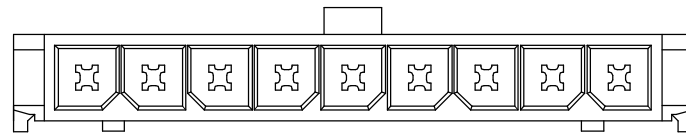

9-CKT

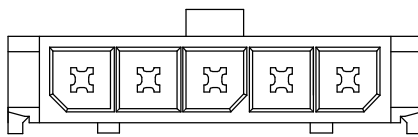

5-CKT

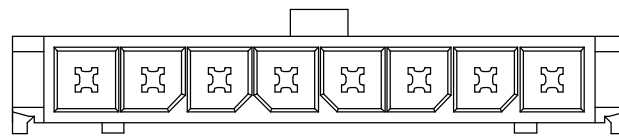

8-CKT

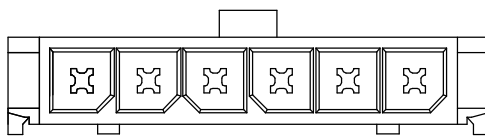

6-CKT

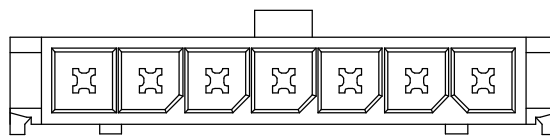

7-CKT

QUALITY SYMBOLS MAJOR Ⓢ CRITICAL Ⓢ GENERAL TOLERANCES (UNLESS SPECIFIED) X. ±0.5 X ±0.38 .XX ±0.25 .XXX ±0.15 ANGLES ±2°	DRAWN BY Tang,En Hui	DATE 19/08/20	
	CHECKED BY Lu,ling Quan	DATE 19/08/20	
	APPROVED BY hsieh, fu yu	DATE 19/08/20	RFG NO. N/A
	UNITS mm		SIZE A4
	SCALE 3 : 1	SHEET NO. 2 OF 2	REV A
			DWG NO. 57923-XXXXX-XXX